

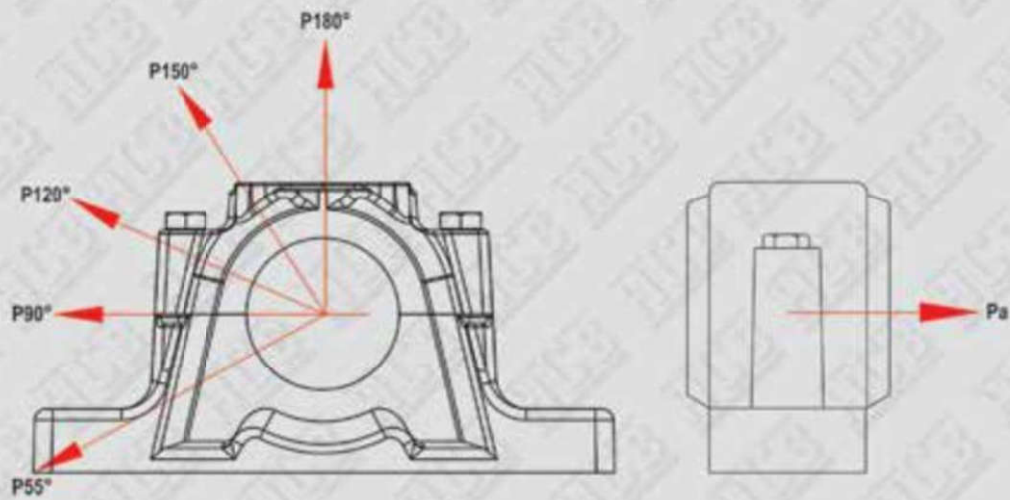

SNH 500-600





| Housing | | Breaking loads | | | | | |
|-------------|-----------------|------------------|------------------|-------------------|-------------------|-------------------|----------------|
| Size | P _{0°} | P _{55°} | P _{90°} | P _{120°} | P _{150°} | P _{180°} | P _a |
| - | kN | kN | kN | kN | kN | kN | kN |
| SNH 505 | 100 | 155 | 95 | 70 | 60 | 80 | 52 |
| SNH 506-605 | 130 | 170 | 100 | 80 | 65 | 85 | 55 |
| SNH 507-606 | 140 | 190 | 115 | 85 | 80 | 95 | 60 |
| SNH 508-607 | 150 | 215 | 130 | 95 | 85 | 110 | 70 |
| SNH 509 | 160 | 230 | 140 | 100 | 90 | 115 | 75 |
| SNH 510-608 | 170 | 265 | 155 | 120 | 110 | 130 | 85 |
| SNH 511-609 | 190 | 275 | 170 | 125 | 115 | 140 | 90 |
| SNH 512-610 | 210 | 300 | 180 | 130 | 120 | 150 | 100 |
| SNH 513-611 | 270 | 340 | 205 | 150 | 130 | 170 | 110 |
| SNH 515-612 | 290 | 410 | 250 | 185 | 160 | 205 | 135 |
| SNH 516-613 | 350 | 430 | 260 | 190 | 175 | 215 | 140 |
| SNH 517 | 370 | 480 | 290 | 205 | 190 | 240 | 155 |
| SNH 518-615 | 430 | 550 | 340 | 250 | 215 | 275 | 180 |
| SNH 519-616 | 450 | 580 | 350 | 260 | 230 | 290 | 190 |
| SNH 520-617 | 470 | 620 | 370 | 280 | 250 | 310 | 200 |
| SNH 522-619 | 600 | 680 | 410 | 310 | 275 | 340 | 220 |
| SNH 524-620 | 800 | 790 | 470 | 350 | 320 | 400 | 260 |
| SNH 526 | 900 | 900 | 540 | 410 | 360 | 450 | 295 |
| SNH 528 | 1000 | 1 050 | 630 | 470 | 430 | 530 | 345 |
| SNH 530 | 1100 | 1 200 | 730 | 540 | 480 | 600 | 390 |
| SNH 532 | 1300 | 1 450 | 860 | 640 | 570 | 720 | 470 |

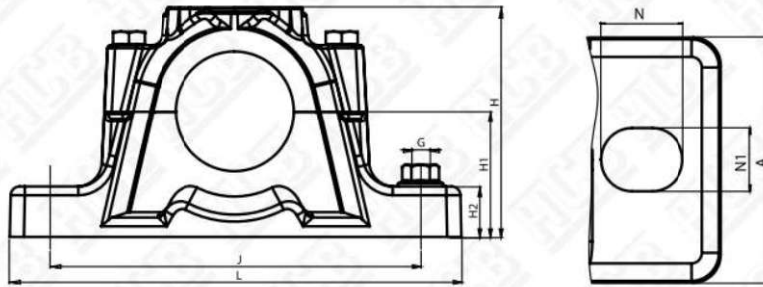

| SHAFT | HOUSING | HOUSING WITHOUT SEALS | BEARING | LOCATING RING | END COVER | SEALS |
|-------|---------|-----------------------|---------|---------------|-----------|-----------|
| Da | | | | | | |
| 20 | SNH 505 | SNH 505 | 1205 K | 2 frb 5/52 | ASNH 505 | TSN 505 G |
| | | | 2205 K | 2 frb 3.5/52 | | - |
| | | | 22205 K | 2 frb 3.5/52 | | - |
| | | | - | - | | - |
| | SNH 605 | SNH 506-605 | 1305 K | 2 frb 7.5/62 | ASNH 605 | TSN 605 G |
| | | | 2305 K | 2 frb 4/62 | | TSN 605 A |
| | | | 21305 K | 2 frb 7.5/62 | | TSN 605 C |
| | | | - | - | | - |
| 25 | SNH 506 | SNH 506-605 | 1206 K | 2 frb 8/62 | ASNH 506 | TSN 506 G |
| | | | 2206 K | 2 frb 6/62 | | - |
| | | | 22206 K | 2 frb 6/62 | | - |
| | | | - | - | | - |
| | SNH 606 | SNH 507-606 | 1306 K | 2 frb 7.5/72 | ASNH 606 | TSN 606 G |
| | | | 2306 K | 2 frb 3.5/62 | | TSN 606 A |
| | | | 21306 K | 2 frb 7.5/62 | | TSN 606 C |
| | | | - | - | | - |
| 30 | SNH 507 | SNH 507-606 | 1207 K | 2 frb 8.5/72 | ASNH 507 | TSN 507 G |
| | | | 2207 K | 2 frb 5.5/72 | | - |
| | | | 22207 K | 2 frb 5.5/72 | | TSN 507 C |
| | | | - | - | | - |
| | SNH 607 | SNH 508-607 | 1307 K | 2 frb 9/80 | ASNH 607 | TSN 607 G |
| | | | 2307 K | 2 frb 4/80 | | TSN 607 A |
| | | | 21307 K | 2 frb 9/80 | | TSN 607 C |
| | | | - | - | | - |
| 35 | SNH 508 | SNH 508-607 | 1208 K | 2 frb 10.5/80 | ASNH 508 | TSN 508 G |
| | | | 2208 K | 2 frb 8/80 | | - |
| | | | 22208 K | 2 frb 8/80 | | TSN 508 C |
| | | | - | - | | - |
| | SNH 608 | SNH 510-608 | 1308 K | 2 frb 9/90 | ASNH 608 | TSN 608 G |
| | | | 2308 K | 2 frb 4/90 | | TSN 608 A |
| | | | 21308 K | 2 frb 9/90 | | TSN 608 C |
| | | | 22308 K | 2 frb 4/90 | | - |

SNH 500-600

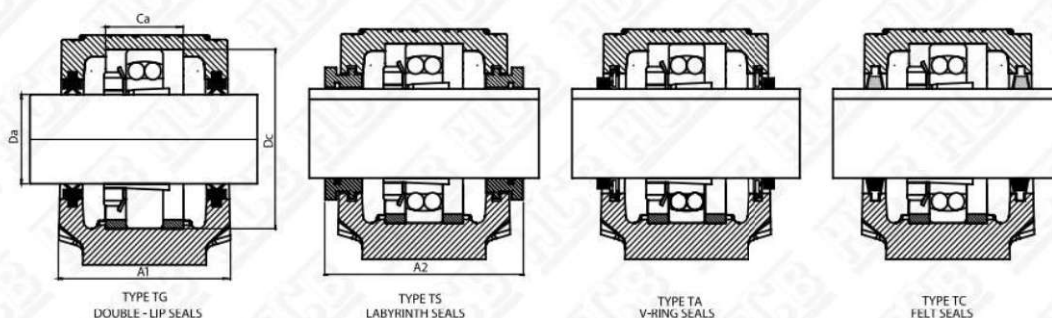

| HOUSING | DIMENSIONS | | | | | | | | | | | | | |
|---------|------------|----------------|-----|-----|-----|----------------|----------------|----|----------------|----------------|----|----------------|----|-----|
| | Dc | C ₂ | L | J | H | H ₁ | H ₂ | A | A ₁ | A ₂ | N | N ₁ | G | Kg |
| SNH 505 | 52 | 25 | 165 | 130 | 74 | 40 | 19 | 46 | 67 | 90 | 20 | 15 | 12 | 1,5 |
| SNH 605 | 62 | 32 | 185 | 150 | 89 | 50 | 22 | 52 | 77 | 89 | 20 | 15 | 12 | 2,2 |
| SNH 506 | 62 | 32 | 185 | 150 | 89 | 50 | 22 | 52 | 77 | 89 | 20 | 15 | 12 | 2,2 |
| SNH 606 | 72 | 34 | 185 | 150 | 93 | 50 | 22 | 52 | 82 | 94 | 20 | 15 | 12 | 2,4 |
| SNH 507 | 72 | 34 | 185 | 150 | 93 | 50 | 22 | 52 | 82 | 94 | 20 | 15 | 12 | 2,4 |
| SNH 607 | 80 | 39 | 205 | 170 | 107 | 60 | 25 | 60 | 85 | 97 | 20 | 15 | 12 | 3,1 |
| SNH 508 | 80 | 39 | 205 | 170 | 107 | 60 | 25 | 60 | 85 | 97 | 20 | 15 | 12 | 3,1 |
| SNH 608 | 90 | 41 | 205 | 170 | 113 | 60 | 25 | 60 | 90 | 102 | 20 | 15 | 12 | 3,8 |

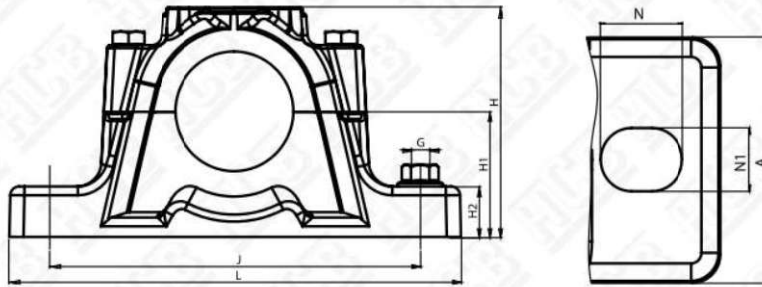

| SHAFT Da | HOUSING | HOUSING WITHOUT SEALS | BEARING | LOCATING RING | END COVER | SEALS |
|-------------|---------|-----------------------------|---------|------------------|-----------|-----------|
| 40 | SNH 509 | SNH 509 | 1209 K | 2 frb 5.5/85 | ASNH 509 | TSN 509 G |
| | | | 2209 K | 2 frb 3.5/85 | | TSN 509 A |
| | | | 22209 K | 2 frb 3.5/85 | | TSN 509 C |
| | | | - | - | | TSN 509 S |
| | SNH 609 | SNH 511-609 | 1309 K | 2 frb 9.5/100 | ASNH 609 | TSN 609 G |
| | | | 2309 K | 2 frb 4/100 | | TSN 609 A |
| | | | 21309 K | 2 frb 9.5/100 | | TSN 609 C |
| | | | 22309 K | 2 frb 4/100 | | TSN 609 S |
| 45 | SNH 510 | SNH 510 | 1210 K | 2 frb 10.5/90 | ASNH 510 | TSN 510 G |
| | | | 2210 K | 2 frb 9/90 | | TSN 510 A |
| | | | 22210 K | 2 frb 9/90 | | TSN 510 C |
| | | | - | - | | TSN 510 S |
| | SNH 610 | SNH 512-610 | 1310 K | 2 frb 10.5/110 | ASNH 610 | TSN 610 G |
| | | | 2310 K | 2 frb 4/110 | | TSN 610 A |
| | | | 21310 K | 2 frb 10.5/110 | | TSN 610 C |
| | | | 22310 K | 2 frb 4/110 | | TSN 610 S |
| 50 | SNH 511 | SNH 511-609 | 1211 K | 2 frb 11.5/100 | ASNH 511 | TSN 511 G |
| | | | 2211 K | 2 frb 9.5/100 | | TSN 511 A |
| | | | 22211 K | 2 frb 9.5/100 | | TSN 511 C |
| | | | - | - | | TSN 511 S |
| | SNH 611 | SNH 513-611 | 1311 K | 2 frb 11/120 | ASNH 611 | TSN 611 G |
| | | | 2311 K | 2 frb 4/120 | | TSN 611 A |
| | | | 21311 K | 2 frb 11/120 | | TSN 611 C |
| | | | 22311 K | 2 frb 4/120 | | TSN 611 S |
| 55 | SNH 512 | SNH 512-610 | 1212 K | 2 frb 13/110 | ASNH 512 | TSN 512 G |
| | | | 2212 K | 2 frb 10/110 | | TSN 512 A |
| | | | 22212 K | 2 frb 10/110 | | TSN 512 C |
| | | | - | - | | TSN 512 S |
| | SNH 612 | SNH 515-612 | 1312 K | 2 frb 12.5/130 | ASNH 612 | TSN 612 G |
| | | | 2312 K | 2 frb 5/130 | | TSN 612 A |
| | | | 21312 K | 2 frb 12.5/130 | | TSN 612 C |
| | | | 22312 K | 2 frb 5/130 | | TSN 612 S |

SNH 500-600

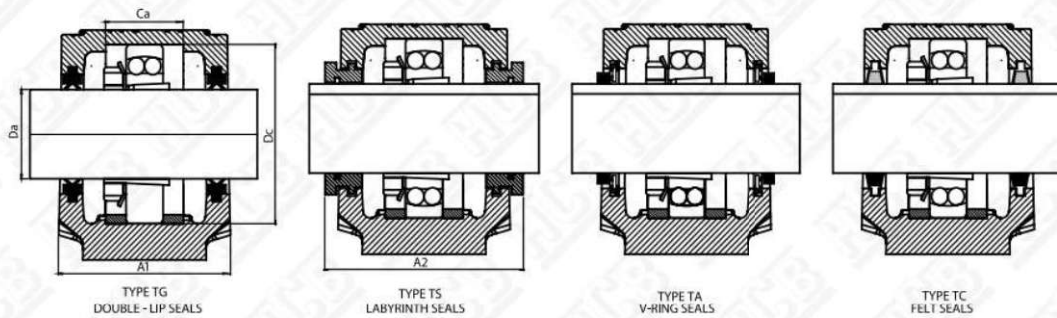

| HOUSING | DIMENSIONS | | | | | | | | | | | | | |
|---------|------------|----------------|-----|-----|-----|----------------|----------------|----|----------------|----------------|----|----------------|----|-----|
| | Dc | C ₂ | L | J | H | H ₁ | H ₂ | A | A ₁ | A ₂ | N | N ₁ | G | Kg |
| SNH 509 | 85 | 30 | 205 | 170 | 109 | 60 | 25 | 60 | 85 | 97 | 20 | 15 | 12 | 3,4 |
| SNH 609 | 100 | 44 | 255 | 210 | 127 | 70 | 28 | 70 | 95 | 107 | 24 | 18 | 16 | 5,4 |
| SNH 510 | 90 | 41 | 205 | 170 | 113 | 60 | 25 | 60 | 90 | 102 | 20 | 15 | 12 | 3,8 |
| SNH 610 | 110 | 48 | 255 | 210 | 133 | 70 | 30 | 70 | 105 | 117 | 24 | 18 | 16 | 5,8 |
| SNH 511 | 100 | 44 | 255 | 210 | 127 | 70 | 28 | 70 | 95 | 107 | 24 | 18 | 12 | 5,3 |
| SNH 611 | 120 | 51 | 275 | 230 | 148 | 80 | 30 | 80 | 110 | 122 | 24 | 18 | 16 | 7,4 |
| SNH 512 | 110 | 48 | 255 | 210 | 133 | 70 | 30 | 70 | 105 | 117 | 24 | 18 | 16 | 5,7 |
| SNH 612 | 130 | 56 | 280 | 230 | 154 | 80 | 30 | 80 | 115 | 127 | 24 | 18 | 16 | 8,2 |

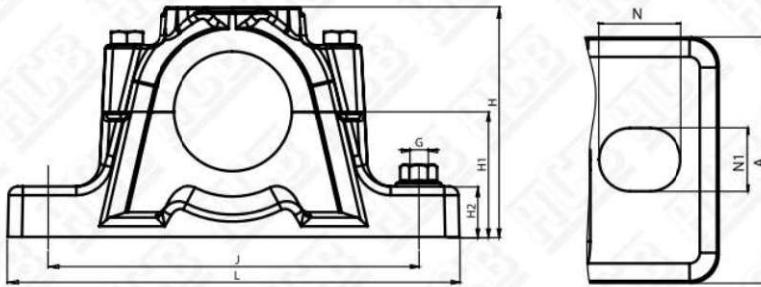

| SHAFT | HOUSING | HOUSING WITHOUT SEALS | BEARING | LOCATING RING | END COVER | SEALS |
|-------|---------|-----------------------|---------|----------------|-----------|-----------|
| Da | | | | | | |
| 60 | SNH 513 | SNH 513-611 | 1213 K | 2 frb 14/120 | ASNH 513 | TSN 513 G |
| | | | 2213 K | 2 frb 10/120 | | TSN 513 A |
| | | | 22213 K | 2 frb 10/120 | | TSN 513 C |
| | | | - | - | | TSN 513 S |
| | SNH 613 | SNH 516-613 | 1313 K | 2 frb 12.5/140 | ASNH 613 | TSN 613 G |
| | | | 2313 K | 2 frb 5/140 | | TSN 613 A |
| | | | 21313 K | 2 frb 12.5/140 | | TSN 613 C |
| | | | 22313 K | 2 frb 5/140 | | TSN 613 S |
| 65 | SNH 515 | SNH 515-612 | 1215 K | 2 frb 15.5/130 | ASNH 515 | TSN 515 G |
| | | | 2215 K | 2 frb 12.5/130 | | TSN 515 A |
| | | | 22215 K | 2 frb 12.5/130 | | TSN 515 C |
| | | | - | - | | TSN 515 S |
| | SNH 615 | SNH 518-615 | 1315 K | 2 frb 14/160 | ASNH 615 | TSN 615 G |
| | | | 2315 K | 2 frb 5/160 | | TSN 615 A |
| | | | 21315 K | 2 frb 14/160 | | TSN 615 C |
| | | | 22315 K | 2 frb 5/160 | | TSN 615 S |
| 70 | SNH 516 | SNH 516-613 | 1216 K | 2 frb 16/140 | ASNH 516 | TSN 516 G |
| | | | 2216 K | 2 frb 12.5/140 | | TSN 516 A |
| | | | 22216 K | 2 frb 12.5/140 | | TSN 516 C |
| | | | - | - | | TSN 516 S |
| | SNH 616 | SNH 519-616 | 1316 K | 2 frb 14.5/170 | ASNH 616 | TSN 616 G |
| | | | 2316 K | 2 frb 5/170 | | TSN 616 A |
| | | | 21316 K | 2 frb 14.5/170 | | TSN 616 C |
| | | | 22316 K | 2 frb 5/170 | | TSN 616 S |
| 75 | SNH 517 | SNH 517 | 1217 K | 2 frb 16.5/150 | ASNH 517 | TSN 517 G |
| | | | 2217 K | 2 frb 12.5/150 | | TSN 517 A |
| | | | 22217 K | 2 frb 12.5/150 | | TSN 517 C |
| | | | - | - | | TSN 517 S |
| | SNH 617 | SNH 520-617 | 1317 K | 2 frb 14.5/180 | ASNH 617 | TSN 617 G |
| | | | 2317 K | 2 frb 5/180 | | TSN 617 A |
| | | | 21317 K | 2 frb 14.5/180 | | TSN 617 C |
| | | | 22317 K | 2 frb 5/180 | | TSN 617 S |

SNH 500-600

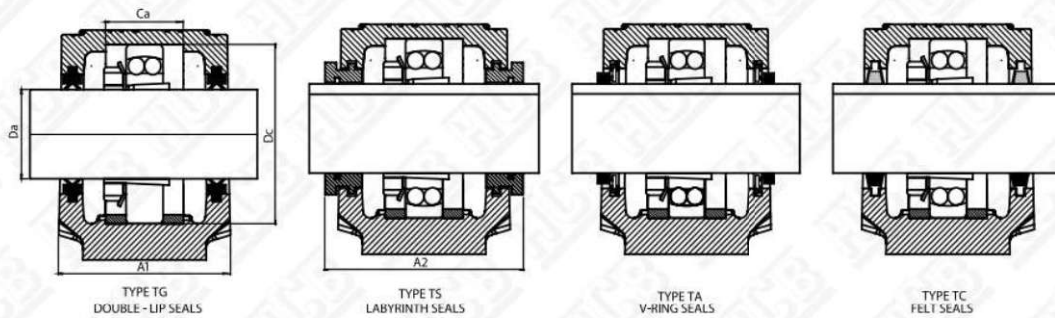

| HOUSING | DIMENSIONS | | | | | | | | | | | | | |
|---------|------------|----|-----|-----|-----|----------------|----------------|-----|----------------|----------------|----|----------------|----|------|
| | Dc | Ca | L | J | H | H ₁ | H ₂ | A | A ₁ | A ₂ | N | N ₁ | G | Kg |
| SNH 513 | 120 | 51 | 275 | 230 | 148 | 80 | 30 | 80 | 110 | 128 | 24 | 18 | 12 | 7,4 |
| SNH 613 | 140 | 58 | 315 | 260 | 175 | 95 | 32 | 90 | 120 | 138 | 28 | 22 | 20 | 10,1 |
| SNH 515 | 130 | 56 | 280 | 230 | 154 | 80 | 30 | 80 | 115 | 133 | 24 | 18 | 16 | 8,2 |
| SNH 615 | 160 | 65 | 345 | 290 | 193 | 100 | 35 | 100 | 140 | 158 | 28 | 22 | 20 | 14,7 |
| SNH 516 | 140 | 58 | 315 | 260 | 175 | 95 | 32 | 90 | 120 | 138 | 28 | 22 | 20 | 10,6 |
| SNH 616 | 170 | 68 | 345 | 290 | 210 | 112 | 35 | 100 | 145 | 163 | 28 | 22 | 20 | 17 |
| SNH 517 | 150 | 61 | 320 | 260 | 183 | 95 | 32 | 90 | 125 | 143 | 28 | 22 | 20 | 11,3 |
| SNH 617 | 180 | 70 | 380 | 320 | 215 | 112 | 40 | 110 | 160 | 178 | 32 | 26 | 24 | 20,4 |

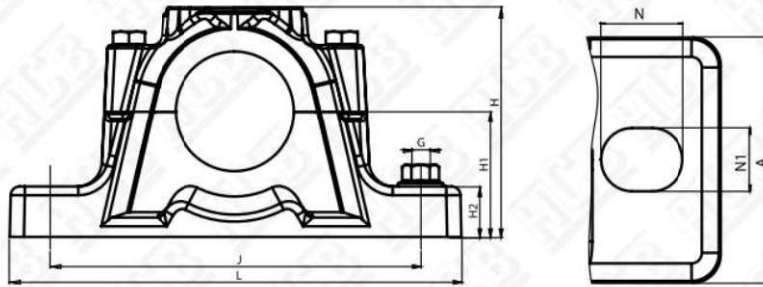

| SHAFT | HOUSING | HOUSING WITHOUT SEALS | BEARING | LOCATING RING | END COVER | SEALS |
|-------|---------|-----------------------|---------|----------------|-----------|-----------|
| Da | | | | | | |
| 80 | SNH 518 | SNH 518-615 | 1218 K | 2 frb 17.5/160 | ASNH 518 | TSN 518 G |
| | | | 2218 K | 2 frb 12.5/160 | | TSN 518 A |
| | | | 22218 K | 2 frb 12.5/160 | | TSN 518 C |
| | | | - | - | | TSN 518 S |
| | SNH 618 | SNH 618 | 1318 K | 2 frb 15.5/190 | ASNH 618 | TSN 618 G |
| | | | 2318 K | 2 frb 5/190 | | TSN 618 A |
| | | | 21318 K | 2 frb 15.5/190 | | TSN 618 C |
| | | | 22318 K | 2 frb 5/190 | | TSN 618 S |
| 85 | SNH 519 | SNH 519-616 | 1219 K | 2 frb 18/170 | ASNH 519 | TSN 519 G |
| | | | 2219 K | 2 frb 12.5/170 | | TSN 519 A |
| | | | 22219 K | 2 frb 12.5/170 | | TSN 519 C |
| | | | - | - | | TSN 519 S |
| | SNH 619 | SNH 522-619 | 1319 K | 2 frb 17.5/200 | ASNH 619 | TSN 619 G |
| | | | 2319 K | 2 frb 6.5/200 | | TSN 619 A |
| | | | 21319 K | 2 frb 17.5/200 | | TSN 619 C |
| | | | 22319 K | 2 frb 6.5/200 | | TSN 619 S |
| 90 | SNH 520 | SNH 520-617 | 1220 K | 2 frb 18/180 | ASNH 520 | TSN 520 G |
| | | | 2220 K | 2 frb 12/180 | | TSN 520 A |
| | | | 22220 K | 2 frb 12/180 | | TSN 520 C |
| | | | 23220 K | 2 frb 4.85/180 | | TSN 520 S |
| | SNH 620 | SNH 524-620 | 1320 K | 2 frb 19.5/215 | ASNH 620 | TSN 620 G |
| | | | 2320 K | 2 frb 6.5/215 | | TSN 620 A |
| | | | 21320 K | 2 frb 19.5/215 | | TSN 620 C |
| | | | 22320 K | 2 frb 6.5/215 | | TSN 620 S |

SNH 500-600

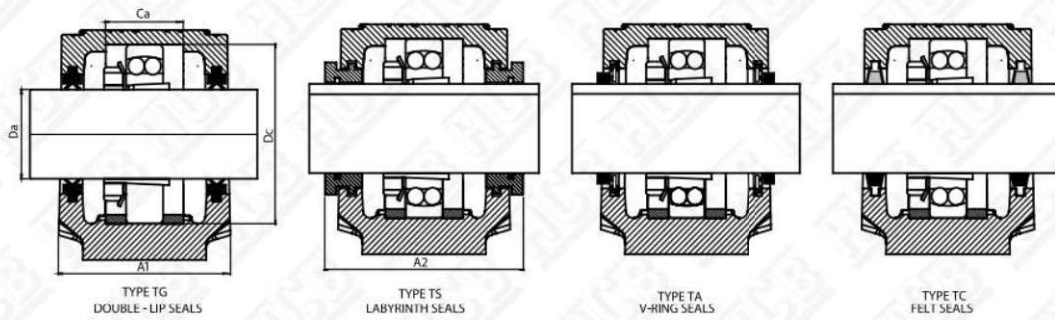

| HOUSING | DIMENSIONS | | | | | | | | | | | | | |
|---------|------------|----|-----|-----|-----|----------------|----------------|-----|----------------|----------------|----|----------------|----|------|
| | Dc | Ca | L | J | H | H ₁ | H ₂ | A | A ₁ | A ₂ | N | N ₁ | G | Kg |
| SNH 518 | 160 | 65 | 345 | 290 | 193 | 100 | 35 | 100 | 140 | 158 | 28 | 22 | 20 | 14,7 |
| SNH 618 | 190 | 74 | 380 | 320 | 229 | 112 | 40 | 110 | 155 | 173 | 32 | 26 | 24 | 16,5 |
| SNH 519 | 170 | 68 | 345 | 290 | 210 | 112 | 35 | 100 | 145 | 163 | 28 | 22 | 20 | 17 |
| SNH 619 | 200 | 80 | 410 | 350 | 239 | 125 | 45 | 120 | 175 | 191 | 32 | 26 | 24 | 25,8 |
| SNH 520 | 180 | 70 | 380 | 320 | 215 | 112 | 40 | 110 | 160 | 178 | 32 | 26 | 24 | 20,4 |
| SNH 620 | 215 | 86 | 410 | 350 | 271 | 140 | 45 | 120 | 185 | 199 | 32 | 26 | 24 | 32,6 |

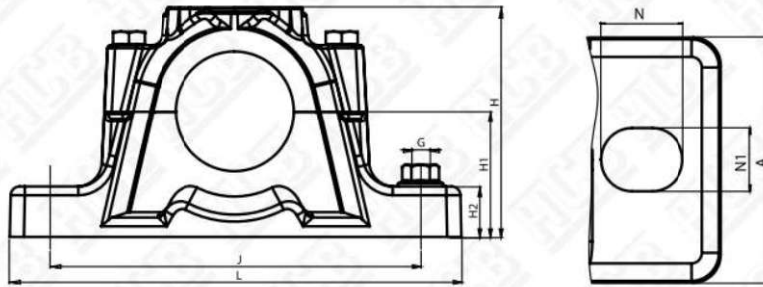

| SHAFT Da | HOUSING | HOUSING WITHOUT SEALS | BEARING | LOCATING RING | END COVER | SEALS |
|-------------|---------|-----------------------------|---------|------------------|-----------|-----------|
| 100 | SNH 522 | SNH 522-619 | 1222 K | 2 frb 21/200 | ASNH 522 | TSN 522 G |
| | | | 2222 K | 2 frb 13.5/200 | | TSN 522 A |
| | | | 22222 K | 2 frb 13.5/200 | | TSN 522 C |
| | | | 23222 K | 2 frb 5.1/200 | | TSN 522 S |
| 110 | SNH 524 | SNH 524-620 | 1224 K | 2 frb 22/215 | ASNH 524 | TSN 524 G |
| | | | 22224 K | 2 frb 14/215 | | TSN 524 A |
| | | | 23224 K | 2 frb 5/215 | | TSN 524 C |
| | | | - | - | | TSN 524 S |
| 115 | SNH 526 | SNH 526-226 | 22226 K | 2 frb 13/230 | ASNH 526 | TSN 526 G |
| | | | 23226 K | 2 frb 5/230 | | TSN 526 A |
| | | | - | - | | TSN 526 C |
| | | | - | - | | TSN 526 S |
| 125 | SNH 528 | SNH 528-228 | 22228 K | 2 frb 15/250 | ASNH 528 | TSN 528 G |
| | | | 23228 K | 2 frb 5/250 | | TSN 528 A |
| | | | - | - | | TSN 528 C |
| | | | - | - | | TSN 528 S |
| 135 | SNH 530 | SNH 530-230 | 22230 K | 2 frb 16.5/270 | ASNH 530 | TSN 530 G |
| | | | 23230 K | 2 frb 5/270 | | TSN 530 A |
| | | | - | - | | TSN 530 C |
| | | | - | - | | TSN 530 S |
| 140 | SNH 532 | SNH 532-232 | 22232 K | 2 frb 17/290 | ASNH 532 | TSN 532 G |
| | | | 23232 K | 2 frb 5/290 | | TSN 532 A |
| | | | - | - | | TSN 532 C |
| | | | - | - | | TSN 532 S |

SNH 500-600

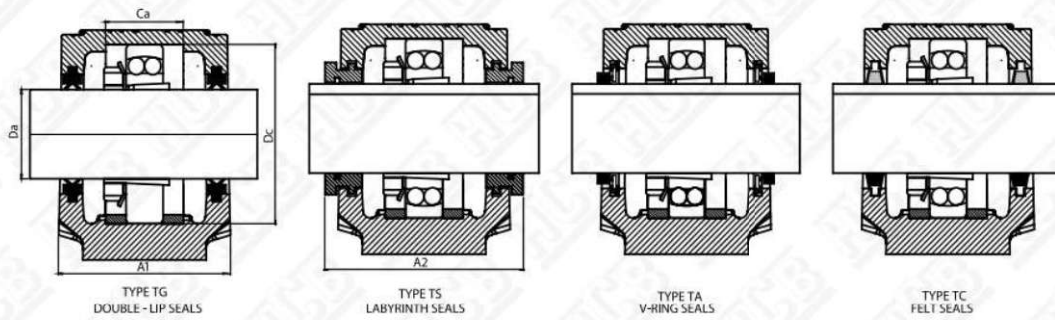

| HOUSING | DIMENSIONS | | | | | | | | | | | | | |
|---------|------------|-----|-----|-----|-----|----------------|----------------|-----|----------------|----------------|----|----------------|----|------|
| | Dc | Ca | L | J | H | H ₁ | H ₂ | A | A ₁ | A ₂ | N | N ₁ | G | Kg |
| SNH 522 | 200 | 80 | 410 | 350 | 239 | 125 | 45 | 120 | 175 | 191 | 32 | 26 | 24 | 25,8 |
| SNH 524 | 215 | 86 | 410 | 350 | 271 | 140 | 45 | 120 | 185 | 199 | 32 | 26 | 24 | 32,6 |
| SNH 526 | 230 | 90 | 445 | 380 | 290 | 150 | 50 | 130 | 190 | 208 | 35 | 28 | 24 | 40,2 |
| SNH 528 | 250 | 98 | 500 | 420 | 302 | 150 | 50 | 150 | 205 | 233 | 42 | 35 | 30 | 50,8 |
| SNH 530 | 270 | 106 | 530 | 450 | 323 | 160 | 60 | 160 | 220 | 241 | 42 | 35 | 30 | 59,7 |
| SNH 532 | 290 | 114 | 550 | 470 | 344 | 170 | 60 | 160 | 235 | 254 | 42 | 35 | 30 | 69 |